

S400 Series

HIGH EFFICIENCY SURGE PROTECTIONS





- *For power supply*
- *For measurement and control devices*
- *For LAN / ICT Networks*

 **SENECA**
www.seneca.it

S400 Series

High Efficiency Surge Protections

High Efficiency Surge Protections are designed to protect systems and electrical devices against pulses and transient overvoltages determined by atmospheric origin and electrical operations. The S400 Series includes:

-  **Type 2/3 Surge Protections for industrial power supply**
-  **Surge Protections for measurement and control devices applied to digital and analog signals (pulse, 0..10 Vdc signals, 0/4..20 mA current loop)**
-  **Surge Protections for ICT networks (token Ring, ISDN, DS1, Ethernet, Power over Ethernet, RS232/422/485 etc.) with high speed data transmission and dispersing level.**

 S400HV-2



 S400LV-1



 S400NET



 K400CL



 S400CL-1



 S400ETH-DSK



COSTS REDUCTION

Overvoltages damage or destroy a large number of electrical devices. In an industrial environment, the hazards are not only restricted to systems and devices. Building technology applications and even residential buildings may be affected.



INTERFERENCE VOLTAGE SUPPRESSION

Switching operations triggered mechanically or electronically generate pulse-like and high-frequency interference voltages. These voltages spread in an unimpeded manner across the cable network.



DIFFERENT DESIGNS

SPD S400 Series in different designs are available for the various areas of application.



EASY CONNECTION

Universal plug-in capability ensures a high degree of comfort in the system. Instead of tampering with the installation, just pull out the plug. The symmetrical plug design facilitates plugging in both directions within the base element. These protective devices can be installed in any control cabinet environment thanks to this flexible installation direction.



APPLICATIONS ON MULTIPLE FIELDS

The surge protection has also to deal with these short-term (temporary) voltage fluctuations. Due to the high rated voltage S400 Series has no limitations and can be used in systems up to 240 V.



REMOTE SIGNALLING

Where present, a common floating remote indication contact enables remote signaling without taking up extra space.



HIGH SECURITY INTERRUPTION LEVEL

The high breaking capacity of the innovative spark gaps also enables their use in low-voltage high-current installations with short-circuit currents of up to 25 kA.



FRONT STATUS SIGNALLING

The mechanical status indicator provides information locally at a glance.

GENERAL INFORMATION ABOUT SURGE PROTECTION DEVICES

IEC EN 60664-1 standard (Insulation coordination for equipment within low-voltage systems - Part 1: principles, requirements and tests) defines as overvoltage all the tensions that have a peak value exceeding, in continuous operation, the value corresponding at the the maximum voltage peak during normal operating conditions. The surge protective devices, commonly called "SPD", are designed to protect systems and electrical equipments against and impulsive transient overvoltages such as the overvoltages caused by lightning strikes or electrical operations. The transient overvoltage consists of a voltage spike of short duration (shorter than a millisecond) which amplitude can exceed the nominal voltage of about ten times. In the electrical and electronic equipment, the immunity to the transient overvol-

tages is of considerable importance. For this reason, devices are equipped with isolating systems between the parts related to the ground and the one related to the neutral.

Isolation can be different from few hundred volts for sensitive electronic devices and up to several kilovolts for an electric motor.

Without an SPD the overvoltage reaches the electrical equipment and if the surge voltage exceeds the impulse withstand of the electrical device its isolation gives no protection causing the current to propagate freely through the instrument and consequently throughout the system.

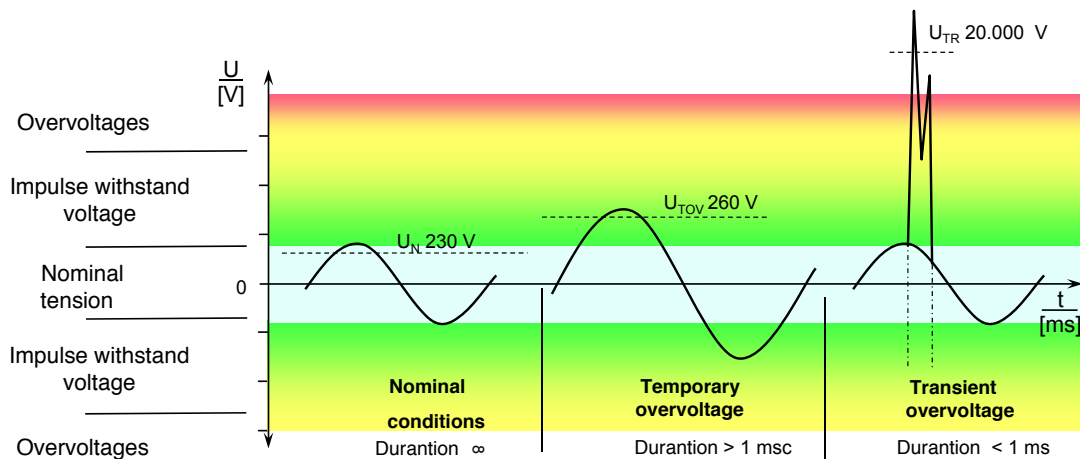

CLASSES, NORMS AND LIGHTNINGS PROTECTION ZONES

The creation of a protection system against lightnings and overvoltages for electrical installations is a fundamental infrastructure requirement for a complex functioning and noise-free electrical and electronic system.

The SPD requirements for the realization of such a system of protection against lightning and overvoltages refer to the lightning protection zones concept according to IEC EN 62305-4 and defined in IEC EN 60364 5-534.

The SPD, in the home and building field, are explained into Type 1, Type 2 or Type 3 SPD, according to the requirements and demands of the typical installation sites selected and tested referring to IEC EN 61643.

SPDs Type 1 have the highest requirements in relation to their discharge capac-

ity. These are used in the lightning and overvoltage protection systems between the Lightning Protection Zone 0A (LPZ 0A) and LPZ 1 (please refer to the image below). This kind of SPD has to repeatedly conduct partial lightning currents with 10/350 μs waveform preventing their propagation into the electrical installation of the structure.

Type 2 SPDs are commonly used between LPZ 0B and LPZ 1 or between LPZ 1 and LPZ 2, their discharge capacity is about of some tens of kA (8/20 μs).

The last kind of SPD involves the protection of user equipment (transition from LPZ 2 to LPZ 3 and over). Type 3 SPDs have the main task to protect the electrical system from any occurring overvoltage between phase and neutral.

Norms		
Description	IEC 61634-1	IEC 61643-11
Combined lightning current arrester	SPD class I	SPD Type 1
Surge protection for distribution, secondary distribution	SPD class II	SPD Type 2
Surge protection for sockets and user equipments	SPD class III	SPD Type 3

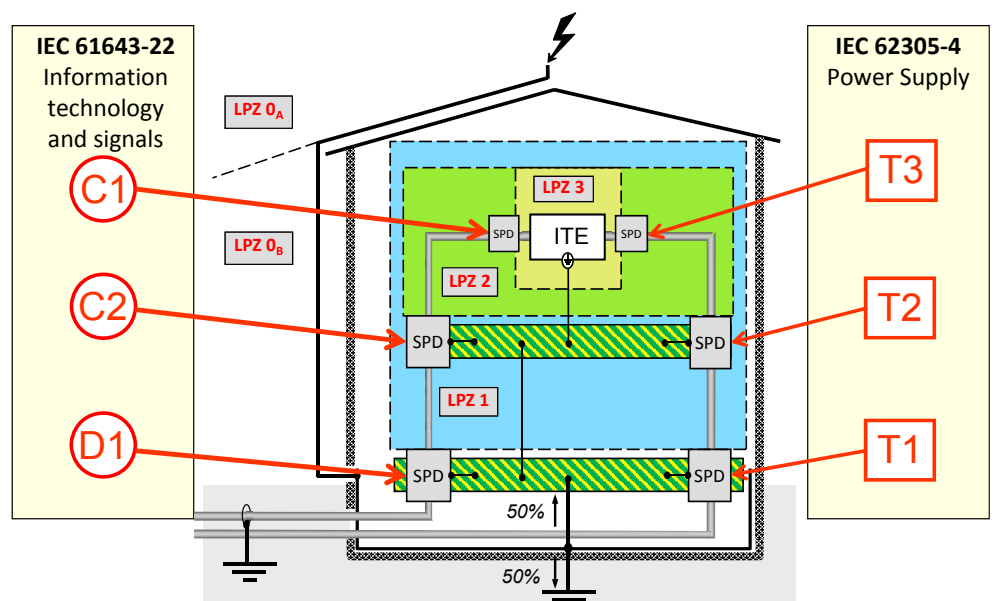

SMART, HIGH EFFICIENCY SURGE PROTECTIONS

TYPE 2/3 SURGE PROTECTION FOR POWER SUPPLY SYSTEMS

S400HV-2



230 Vac surge protection, type 2 at 3 conductors (L, N, PE)

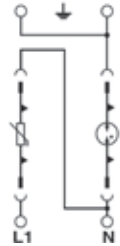

S400LV-1



Type 3 24 Vac/dc Surge Protection with FM contact at 3 conductors (L, N, PE)

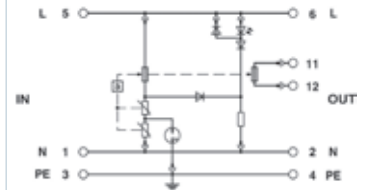

PROTECTION DATA (L-N / N-PE / L-PEN)

IEC category / EN type	II / T2	III / T3
Nominal voltage UN	240 Vac	24 Vac/dc
Maximum continuous operating voltage UC	L-N 335 Vac / N-PE 260 Vac	34 Vac/dc
Nominal discharge surge current In (8/20) µs	L-N 20 kA / L-PE 20 kA / N-PE 20 kA	1 kA
Max. discharge surge current I _{max} (8/20) µs	L-N 40 kA / L-PE 40 kA / N-PE 40 kA	1 kA
Lightning test current I _{imp} (10/350) µs per conductor		
Nominal Current In		
Nominal discharge surge current In (8/20) µs		
Protection Level Up	L-N ≤ 1,5 kV / L-PE ≤ 1,5 kV / N-PE ≤ 1,5 kV	L-N ≤ 180 V / L-PE ≤ 550 / N-PE ≤ 550
Residual voltage at 5 kA	L-N ≤ 1,2 kV / L-PE ≤ 1,2 kV / N-PE ≤ 150 V	
Combination wave Uoc		2 kV
Response time tA	L-N ≤ 25 ns / N-PE ≤ 100 ns	L-N ≤ 25 ns / L-PE ≤ 100 ns / N-PE ≤ 100 ns

GENERAL DATA

Max. required backup fuse according IEC	125 A (gG) - 80 A (gG) passing through wiring	16 Aac - 10 Adc
Resistance against short circuit (with max backup fuse) I _p	25 kA	
Cut-off frequency f _g (3dB) Symmetrical in the 50 Ohm system		
Resistance per path		
Output voltage limitation @ 1 kV/µs, static Core-Core / Core-Ground		
Connection data solid / stranded / AWG	1,5..35 mm ² / 1,5..25 mm ²	0,2..4 mm ² / 0,2..2,5 mm ²
Dimension (l x h x w)	35,6 x 90 x 58 mm	17,7 x 90 x 65,5 mm
Temperature range	-40°C.. +80°C	-40°C.. +80°C
Protection Degree	IP20	IP20
Inflammability class according to UL 94	V0	V0
Case	PA 6.6	PA 6.6
Connection Interface	Screw connection	Screw connection
Protocols		
Test Norms	IEC 61643-11 / EN 61643-11	EN 61643-11
Certifications	CE, UL/cUL/cULus Recognized	CE,

FM CONTACT

Connection data solid / stranded / AWG		0,2..4 mm ² / 0,2..2,5 mm ²
Max operating voltage		250 Vac / 30 Vdc
Max operating current		1.5 Aac (250 Vac) / 1 Adc (30 Vdc)

SURGE PROTECTION FOR MEASUREMENT AND CONTROL DEVICES

SURGE PROTECTIONS FOR ICT NETWORKS AND EQUIPMENTS

K400CL



Analog and Digital Signals Surge Protection, 6,2 slim mm

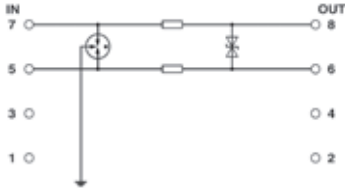

S400CL-1



pending

Analog and Digital Signals Surge Protection with knife disconnecter

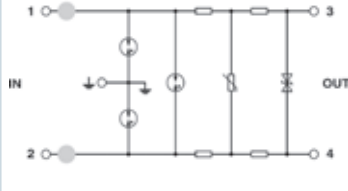

S400ETH-DSK

Cat.5 → 100 Mbps
Cat.5e → 1 Gbps
(Cat. 6 cable)

PoE
power over
ethernet



Ethernet Networks Surge Protections, Class.D/Cat.5, 1Gbit/s, PoE

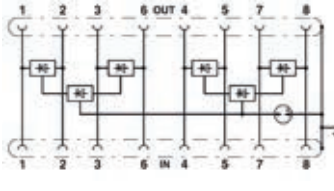

S400NET



Ethernet, serial, fieldbus networks Surge Protections, 5 wires

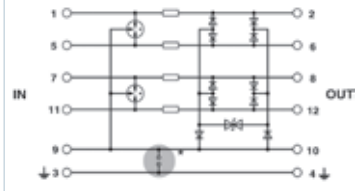

C1 / C2 / C3 / D1	C1 / C2 / C3 / D1	B2 / C1	C1 / C2 / C3 / D1
24 Vdc	24 Vdc		5 Vdc
36 Vdc / 25 Vac	30 Vdc / 21 Vac	±5 Vdc (±57 Vdc / PoE+)	5,2 Vdc / 3,6 Vac
(Core-Core) 5 kA / (Core-Ground) 5 kA	(Core-Core) 5 kA / (Core-Ground) 5 kA	(Core-Core) 350 A / (Core-Ground) 350 A	(Core-Core) 10 kA / (Core-Ground) 10 kA
(Core-Core) 10 kA / (Core-Ground) 10 kA			(Core-Core) 10 kA / (Core-Ground) 10 kA
500 A	500 A		
350 mA (40°C)	300 mA (40°C)	≤1,5 A (25°C)	450 mA (45°C)
20 kA	10 kA		20 kA
(Core-Core) ≤50 V (C3-10A) / (Core-Ground) ≤650 V (C1-500 V / 250A)	(Core-Core) ≤ 45 V / (Core-Ground) ≤ 650 V	(Core-Core) ≤90 V (B2-1kV/25A) ≤ (Core-Ground) 700 V (B2-1kV/25A)	(Core-Core) ≤ 45 V (C3-25A) / (Core-Ground) ≤ 45 V (C3- 25A)
(Core-Core) ≤1 ns / (Core-Ground) ≤100 ns	(Core-Core) ≤1 ns / (Core-Ground) ≤100 ns	(Core-Core) ≤1 ns / (Core-Ground) ≤100 ns	(Core-Core) ≤500 ns / (Core-Ground) ≤500 ns
315 mA	315 mA		500 mA
tip.6 MHz	tip.6 MHz	> 100 MHz	tip. 60 MHz
3,3 Ohm	3,3 Ohm		2,2 Ohm
		(core-core) ≤ 35V / (Core-Ground) ≤ 700V	(core-core) ≤ 15V / (Core-Ground) ≤ 15 V
0,14..2,5 mm ² / 0,2..2,5 mm ²	0,2..2,5 mm ² / 0,2..2,5 mm ²		0,2..4 mm ² / 0,2..2,5 mm ²
6,2 x 93 x 102,5 mm	6,2 x 94,8 x 69,1 mm	28 x 110 x 60 (76 with connection) mm	17,7 x 90 x 65,5 mm
-40°C.. +80°C	-40°C.. +80°C	-40°C.. +80°C	-40°C.. +80°C
IP20	IP20	IP20	IP20
V0	V0	V0	V0
PBT	PA 6.6	ABS	PA
Screw connection	Screw connection	RJ45	Screw connection
		Token Ring, ISDN, DS1, Ethernet, Power over Ethernet	PROFIBUS DP, RS485, RS422, INTERBUS remote bus, CAN Bus, ModBUS RTU/ASCII/TCP-IP
IEC 61643-21 / DIN EN 61643-21 / IEC 60664-1 / EN 60079-11 CE, UL Listed	CE	IEC 61643-21 / EN 50173-1 / ISO/IEC 11801-Am.1 CE, UL Listed	IEC 61643-21/A1 / EN 61643.-21/A1 CE, UL Listed

APPLICATION EXAMPLES

PROTECTION AND ISOLATION FOR POWER SUPPLY TYPE 2 AND 3

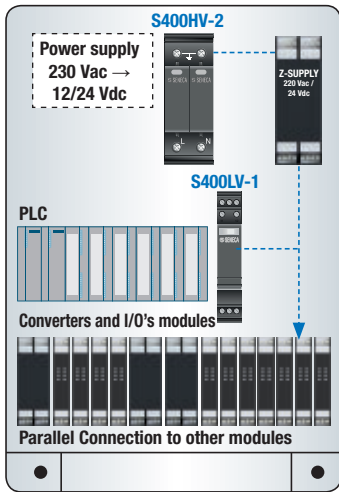

Automation Panels, Marshalling Panels, Panel of PLC & DCS command and machines control, Distribution Panels, Electrical Panels Power Center, MCC Panels

PROTECTION AND ISOLATION FOR POWER SUPPLY TYPE 2 AND 3

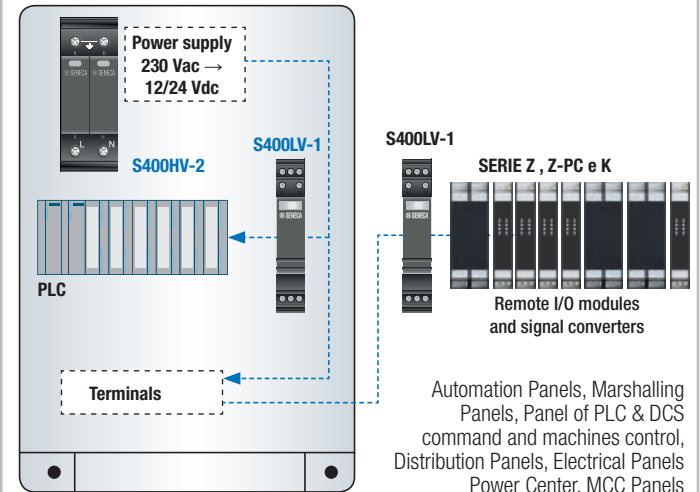

Automation Panels, Marshalling Panels, Panel of PLC & DCS command and machines control, Distribution Panels, Electrical Panels Power Center, MCC Panels

PROTECTION OF A PULSE MEASUREMENT DEVICE (REED, NAMUR, PNP, NPN, HALL EFFECT, ETC)

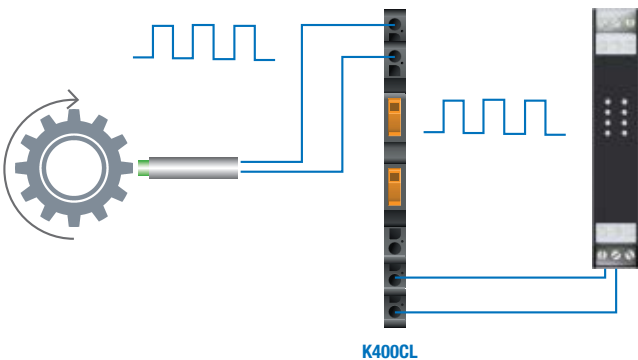

PROTECTION OF AN ANALOGUE MEASUREMENT DEVICE

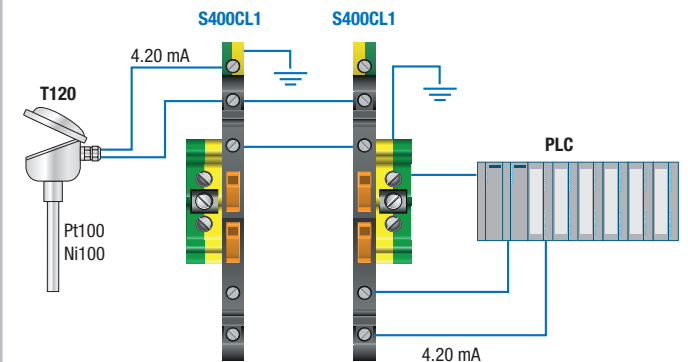

PROTECTION OF IT SIGNALS

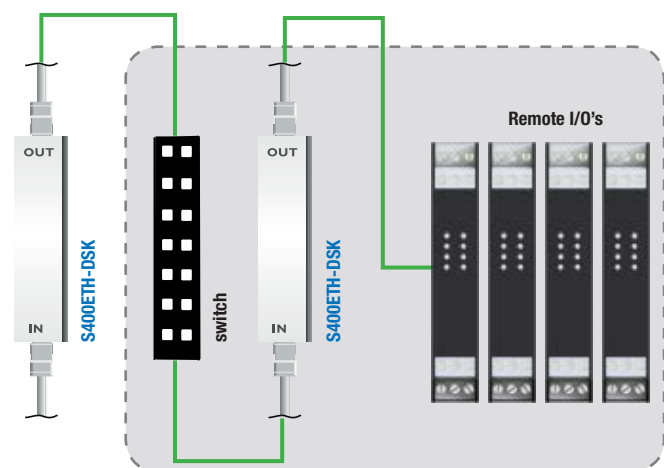

Ethernet Connection with switch placed on Electrical Panel in local

PROTECTION OF IT SIGNALS & FIELDBUS

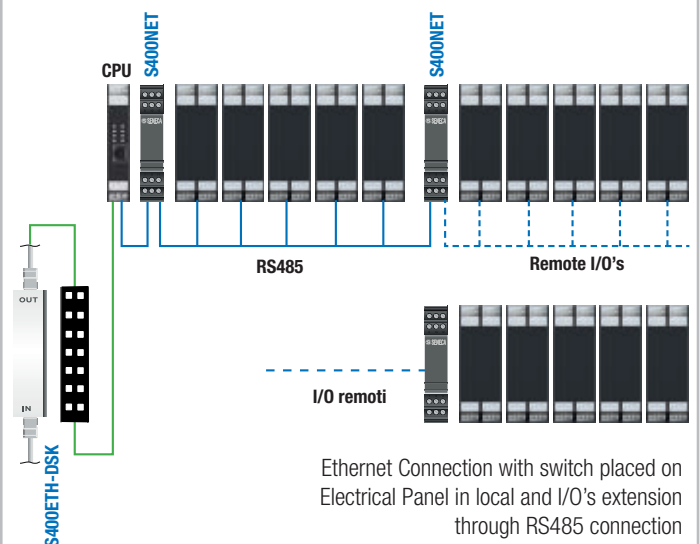

Ethernet Connection with switch placed on Electrical Panel in local and I/O's extension through RS485 connection

WAVE SHAPES 10/350 μ s AND 8/20 μ s

Latest standards has fixed 2 kind of wave shapes to simulate the direct fulmination, the indirect fulmination and the effects due to electrical operations. The shape of the long lasting wave (10/350 μ s) simulates the direct fulmination, with a high level of energy transmission.

The lightning can be considered typically as a current generator which injects a current wave 10/350 μ s in the network.

The shape of the short lasting wave with a low level of energy trasmission (8/20 μ s) represents the indirect fulmination, or the effects due to electrical operations or parasitic interferences.

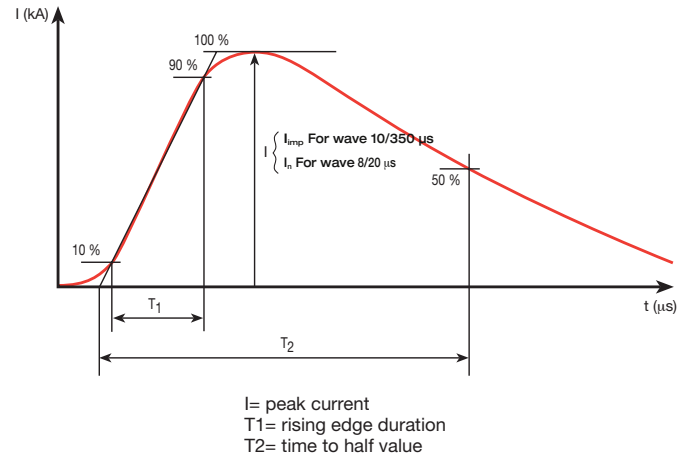
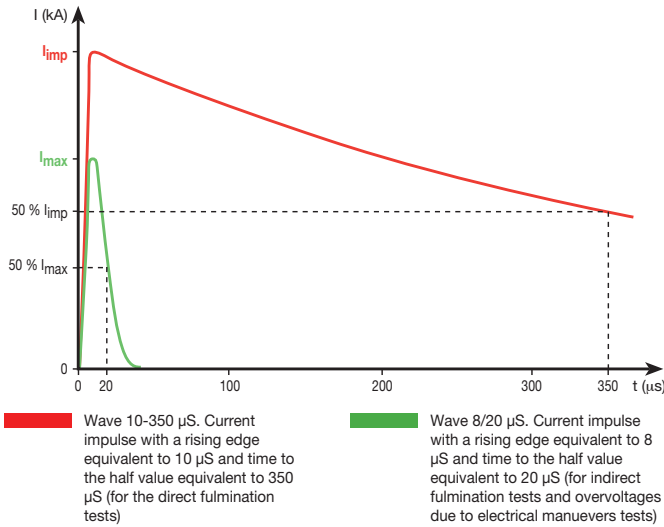

IMPULSE WITHSTAND VOLTAGE OF EQUIPMENT

According to the IEC 60364 -4-44, IEC 60664-1 and IEC 60730-1, equipment immunity levels to impulsive overvoltages are classified in 4 categories (as shown in the following table)

Category	230 / 400 V	400 / 690 V	Examples
I	1500 V	2500 V	Electronic equipments containing electronic circuits particularly sensitive: - Servers, Computers, TV, HIFI, Alarms etc. - Appliances with electronic components etc.
II	2500 V	4000 V	Electric equipment (not containing electronic circuits), electrical tools etc.
III	4000 V	6000 V	Power panels, switchgears (switches, insulators, plugs etc.) electrical conduits and accessories (wires, bars, enclosures etc.)
IV	6000 V	6000 V	Equipments for industrial applications and equipments such as: electric motors permanently connected to plants, power meters, transformers etc.

The SPD protection level UP has to be chosen in relation to the equipment to be protected, and in particular to its Impulse immunity category.

GLOSSARY

Arc voltage U_{bo}

The arc voltage is the instantaneous value of the voltage on a discharge path (arc discharge) during an arresting process.

Follow current I_f

Current which flows through the SPD following discharge and is supplied by the mains. The follow current differs considerably from the continuous operating current.

Impulse withstand voltage U_{st}

The peak value of the highest surge voltage with a predefined form and polarity, which will not lead to a disruptive discharge under the specified test conditions. Note: the impulse withstand voltage is equal to or greater than the rated surge voltage.

Lightning surge current I_{imp}

Lightning surge currents are characterized by the parameters peak value, charge, specific energy, and current increase rate. The lightning surge current I_{imp} is a measurement for the discharge capacity of lightning arresters (class I). It is determined according to a defined test procedure using 10/350 μ s waveform test pulses.

Lightning test current

The (10/350) μ s lightning test current has a rise time of 10 μ s and a decay time to half-value of 350 μ s.

Maximum continuous voltage U_c

The rated voltage is the maximum permissible r.m.s. value of the power-frequency AC voltage, which may be permanently applied to the protective paths of the arrester.

Nominal current I_n or load current I_l

Highest continuous current for products according to IEC 61643 which can flow through the surge protective device at the specified temperature without altering the electrical operating properties. For higher operating temperatures, the nominal current is lower (derating).

Nominal discharge surge current I_n

Peak value of the current flowing through the SPD with surge form (8/20) μ s. It is used to classify the SPD according to class II. Source: EN 61643-11

Nominal voltage U_n

A suitable rounded voltage value, which is specified by the manufacturer for equipment for the purpose of designation or identification.

Protection level U_p

A parameter that characterizes the performance capabilities of the SPD with regard to voltage limitation via its connection terminal blocks. This value, which should be specified by the manufacturer, must be greater than the highest measured value of the clamping voltages.

Residual voltage U_{res}

The peak voltage value that occurs while discharge surge current is flowing via the terminal blocks of the SPD. Source: EN 61643-11:2002

S400 SERIES

DIMENSION

S400HV-2

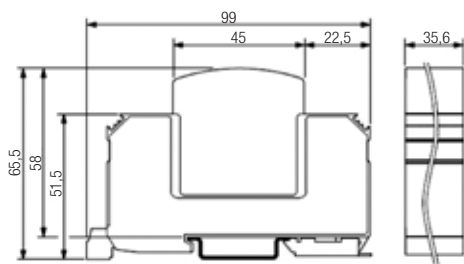

S400LV-1

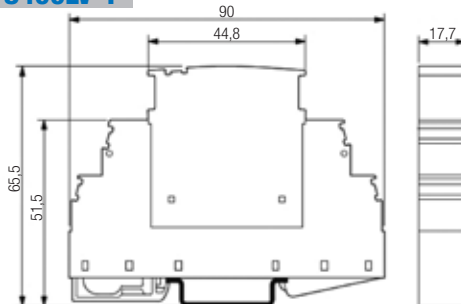

K400CL

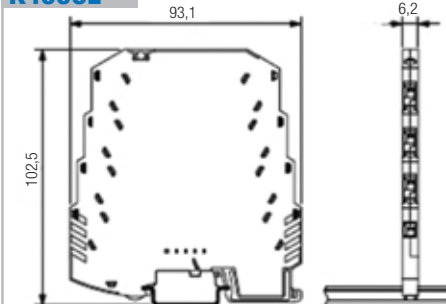

S400CL1

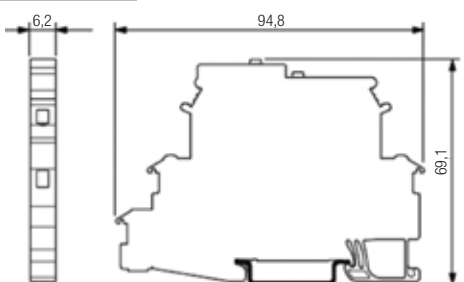

S400ETH-DSK

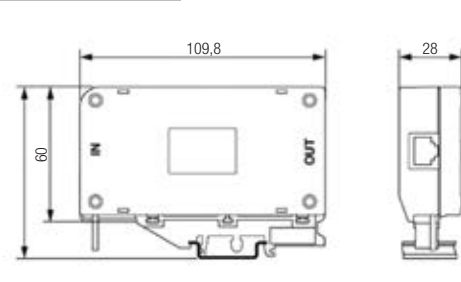

S400NET

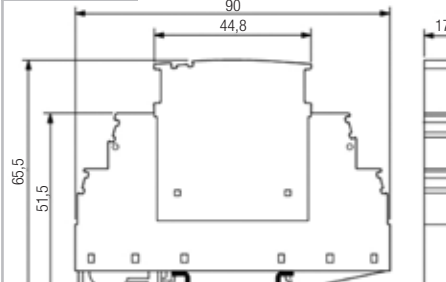

ACCESSORIES

S400HV-2-RIC-SL



S400HV-2-RIC-SN



S400LV-1-RIC-SL



S400NET-RIC-SL



ORDER CODES

Code	Description
K400CL	Analog and Digital Signals Surge Protection, 6,2 mm
K400CL-10	K400CL-1 10 pieces kit
S400HV-2	Type 2 230 Vac Surge Protection at 3 conductors (L, N, PE)
S400HV-2-RIC-SL	S400HV2 plug spare 1L-NPE, no FM contact
S400HV-2-RIC-SN	S400HV2 plug spare N/PE
S400LV-1	Type 3 24 Vac/dc Surge Protection with FM contact at 3 conductors (L, N, PE)
S400LV-1-RIC-SL	S400LV-1 plug spare, with contact FM
S400CL-1	Analog and Digital Signals Surge Protection with knife disconnecter
S400CL-1-15	S400CL-1 10 pieces kit
S400CL-1-P5	S400CL-1 closing side (5 pieces)
S400NET	Ethernet, serial, fieldbus networks Surge Protections, 5 wires
S400NET-RIC-SL	S400NET plug spare
S400ETH-DSK	Ethernet Networks Surge Protections, Class.D/Cat.5 (100 Mbps)/5e (1 Gbps), 1Gbps, PoE